

Anti-Slip Hi-Traction™ INSTALLATION DIAGRAMS

(Step Covers)

Step Cover Installation with Mechanical Fasteners

(See back for adhesive instructions)

Step Cover Installation Over Grating

Install utilizing Universal Saddle Clip Assemblies with Slotted Truss Head Bolt, Nut and Lock Washer (All Stainless Steel)

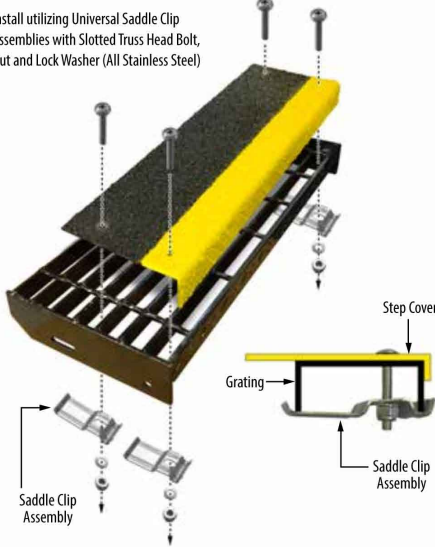

Step Cover Installation Over Diamond/Checker Plate

Install utilizing Self-Tapping or Self-Drilling (Tek) Screws or Rivets and Low Profile Head, Nuts and Bolts. (Depending on your particular application)

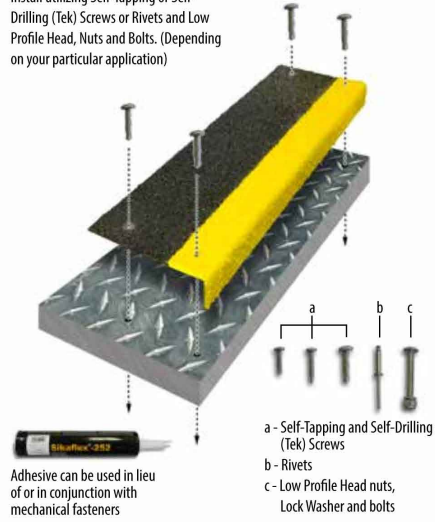

Step Cover Installation Over Concrete

Install using screws and masonry fasteners.

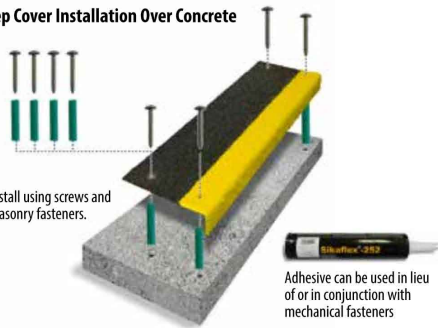

Step Cover Installation Over Wood

Install using 1/2" standard type screws

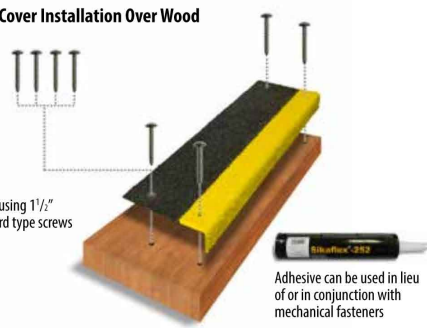

Please refer to the Installation guidelines literature for detailed "step-by-step" written instructions.

NOTE: Please reference red "Attention" instructions on back of this page for air tool usage and instructions.

recommends placing mechanical fasteners 1" x 1" in each corner of your Anti-Slip Cover with spacing 10" to 14" between each fastener.

* The number of Saddle Clip Assemblies is directly influenced by the condition of the grating to be covered. New and good condition grating may not require as many Saddle Clip Assemblies.

† Good condition is considered flat/level and non-corroded. Contact Safeguard to discuss your application.

Anti-Slip Hi-Traction™ INSTALLATION DIAGRAMS

(Step Covers)

Step Cover Installation using adhesive

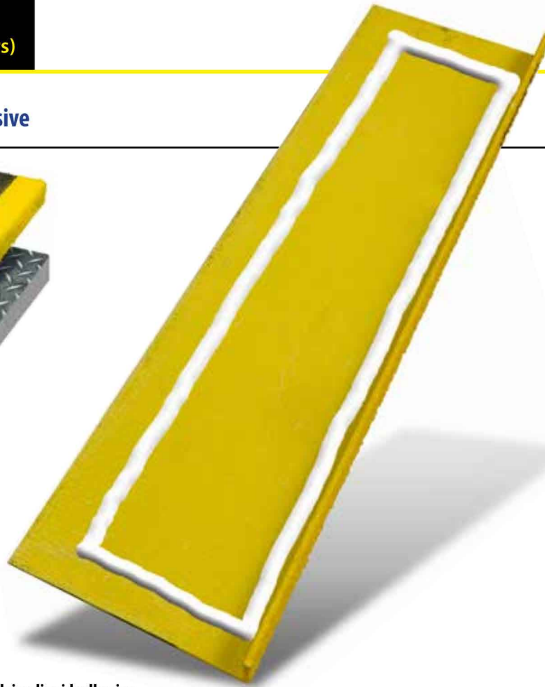
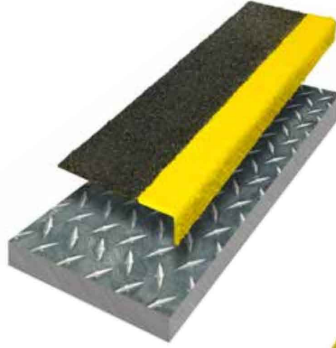

Red indicates pattern to follow when applying liquid adhesive.



3" - 9" Step Cover

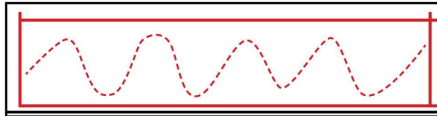

>9" - Step Cover

Minimum adhesive usage shown.
Depending on condition of substrate more can be applied, or troweled.

When using liquid adhesive, please refer to detailed installation and surface preparation instructions. Follow the pattern to the left for maximum adhesion when installing over diamond plate, concrete, and wood.



ATTENTION:



Reduce the speed of your pneumatic air tools to prevent thread galling and bolt snapping while installing saddle clips.

We recommend using a #2 Phillips screwdriver or adapter when installing to avoid head stripping.

The use of a thread lubricant is also recommended to reduce heat and assist in a smooth installation of this product.